

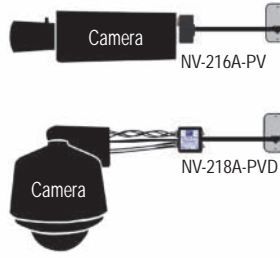

Power Supply Passive Receiver Hub Installation Guide

Models NV-4PS13-PVD, NV-8PS13-PVD and NV-16PS13-PVD

Camera Location and Transmitter Connections



IDF | MDF | Control Room and Receiver Connections

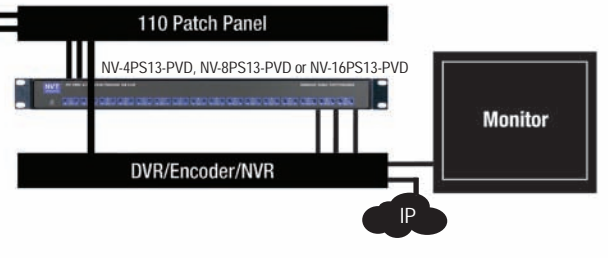

IMPORTANT SAFETY INSTRUCTIONS

- 1) Read these instructions.
- 2) Keep these instructions.
- 3) Heed all warnings.
- 4) Follow all instructions.
- 5) Do not use this apparatus near water.
- 6) Clean only with a dry cloth.
- 7) Do not block any ventilation openings.
- 8) Install in accordance with the manufacturer's instructions.
- 9) Do not install near any heat sources such as radiators, heat registers, stoves or other apparatus (including DVRs) that produce heat.
- 10) Do not defeat the safety purpose of the polarized or grounding-type plug. A polarized plug has two blades with one wider than the other. A grounding type plug has two blades and a third grounding prong. The wider blade or the third prong are provided for your safety. If the provided plug does not fit into your outlet, consult an electrician for replacement of the obsolete outlet.
- 11) Protect the power cord from being walked on or pinched particularly at plugs, convenience receptacles, and the point where they exit from the apparatus.
- 12) Only use attachments/accessories specified by the manufacturer.
- 13) Use only with cart, stand, tripod, bracket, or table specified by the manufacturer, or sold with the apparatus. When a cart is used, use caution when moving the cart/apparatus combination to avoid injury from tipover.
- 14) Unplug this apparatus during lightning storms or when unused for long periods of time.
- 15) Refer all servicing to qualified service personnel. Servicing is required when the apparatus has been damaged in any way, such as a power supply cord or plug is damaged, liquid has been spilled, or objects have fallen into the apparatus, the apparatus has been exposed to rain or moisture, does not operate normally, or has been dropped.

⚠ This installation should be made by a qualified service person and should conform to all local codes.

TO REDUCE THE RISK OF ELECTRICAL SHOCK, DO NOT REMOVE COVER OR BACK. NO USER SERVICEABLE PARTS INSIDE. REFER SERVICING TO QUALIFIED SERVICE PERSONNEL.

WARNING: TO REDUCE THE RISK OF ELECTRICAL SHOCK, DO NOT EXPOSE THIS APPARATUS TO RAIN OR MOISTURE.

⚠ WARNING - Do not install the unit in an environment where the operating ambient temperature exceeds 122° F (50° C). The ventilation should not be impeded by covering the ventilation openings with items, such as newspapers, table-cloths, curtains, etc. No naked flame sources, such as lighted candles should be placed on the apparatus.

⚠ WARNING - Do not interconnect multiple outputs.

⚠ WARNING - The apparatus shall not be exposed to dripping or splashing and no objects filled with liquids, such as vases, shall be placed on the apparatus.

⚠ WARNING - Use only a Certified power cord and plug (coupler / mains) assemblies for location installed.

⚠ WARNING - Power cord is regarded as main disconnect.

⚠ WARNING - The appliance coupler (power cord/mains) shall remain readily operable.

⚠ WARNING - For safety, never put NVT signals in the same conduit as high-voltage wiring.

⚠ WARNING - Do not restrict airflow around any active powered NVT products.

The NVT Power Supply Passive Receiver Hub combines a 1 Amp/ channel power supply with video and telemetry data, for 4 to 16 cameras, all over UTP wire. Designed for installation in the wiring/IDF telecom closet, or at the Control /MDF room, the Hub consolidates connectivity via standard 4-pair RJ45 EIA/TIA 568B compliant premises wiring and pinouts.

At the camera, Power, Video and Data connections are made using the NV-216A-PV (power-video only) the NV-218A-PVD transceiver or the NV-226J-PV via an RJ45 connector and a single 4-pair cable. IDF/MDF/Control room connections are BNC. Telemetry data connections (if required) achieved with single 4-pair RJ45 cable for each group of four cameras.

The NV-4PS13-PVD supports up to 4 cameras in a compact rack, wall, or desk-mount chassis. The NV-8PS13-PVD supports up to 8 cameras and the NV-16PS13-PVD supports up to 16 cameras in a 1U wall, desk or rack-mount chassis.

Wire Type

The Power Supply Passive Receiver operates well with Category Unshielded Twisted-Pair (UTP) wire, 24 AWG-22AWG (0,5mm-0,64mm).

The video signal may co-exist in the same wire bundle as other video, telephone, data, control signals, or low-voltage power. It is also OK to run NVT signals near electromagnetic fields (in accordance with National Electrical Code, and other local safety requirements).

DO NOT USE individually shielded twisted pair. Overall shielded, multi-pair (6pr +) Cat5 is OK.

Do NOT use un-twisted wire.

Wire in underground conduit or wet locations must be polyethylene-jacketed, gel-filled.

Due to near-end crosstalk, do not send a transmit and a receive signal in the same wire bundle. Exception: Up to 2,000ft (600m) Category 5.

Wire in plenum environments must be plenum-rated, per local codes.

RS-422, RS-485, and Up-the-Coax Pan/Tilt/Zoom telemetry signals are supported.

NVT recommends the use of factory-crimped RJ45 patch cables rather than unreliable field-crimped RJ45s to connect between the NVT device and an adjacent female RJ45 jack.

Wire Distance

All measured distances include any coax in the path. Wire resistance may be measured with an ohm-meter by shorting the two conductors together at the far end, and measuring the loop-resistance out and back.

Loop Resistance per 1000ft (300m)

24 AWG	(0,53 mm)	=	52 ohms
23 AWG	(0,57 mm)	=	42 ohms
22 AWG	(0,64 mm)	=	33 ohms

Wire distances are limited to the minimum of:

POWER DISTANCE - the power loss along the wire from the Power Supply Passive Receiver Hub out to the camera, - or the -

VIDEO DISTANCE - the video signal distance limit from camera to the Power Supply Passive Receiver, not to exceed 750ft (225m).

Connecting PVD at the Camera End

Use the NV-216A-PV for fixed cameras, the NV-218A-PVD or the NV-226J-PV for fixed or P/T/Z cameras. Install per the instructions that come with the transmitting device using 4-pair wire and RJ45 connectors. Wiring pinouts are:

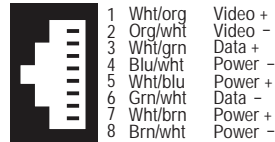

Connecting PVD at the Power Supply Passive Receiver Hub

Bring the 4-pair PVD cable from each camera back to the location of the Power Supply Passive Receiver. NVT recommends that an RJ45 Patch Panel be used here in conjunction with RJ45 patch-cords. Use of these EIA/TIA 568B compliant practices allows for easy testing with an RJ45 (LAN) tester, as well as moves and changes.

Connect the PVD signals into ports on the front of the Power Supply Passive Receiver Hub.

Connecting Power

CAUTION: Before applying power, set voltage selection switch to proper input line voltage.

⚠ Test your PVD connections with an RJ45 (LAN) wiring tester prior to applying power.

Connect the IEC cable between the power inlet and a grounded electrical outlet. Switch on the power switch and observe the blue power LED.

LED Channel Power Status

Channel Power Status LEDs (each channel)

OFF: No camera connected (<50mA)

GREEN: Valid camera load detected

AMBER: Caution: Miswire possible

Detects that current in each of the four power conductors is the same, allowing for the detection of open conductors. For short wire runs under 100 feet on fixed cameras, small mis-matches in connector resistance may cause LEDs to show Amber. In this case, first verify the wire continuity with a ohm meter or LAN tester. If no fault found then ignore as condition is normal. Above 100 feet, or with high current P/T/Z cameras, the amber LED is an indication that the wire continuity should be checked with a ohm meter or LAN tester for miswires.

RED: Over-current shutdown. Check for shorts in the wiring.

Video Distance

Recommended wire distances for best resolution is shown in chart below. Wire distance between the camera and the Power Supply Passive Receiver Hub should not exceed:

Passive-to-Passive 750ft (225m)

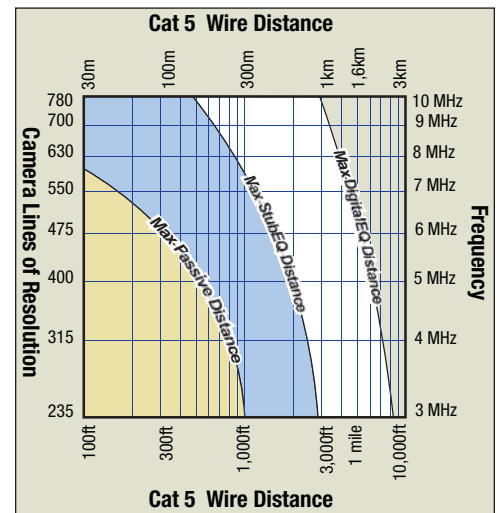

Power Distance

Wire distance between the Power Supply Passive Receiver and the camera is dependent on the camera's current draw. Please refer to the Power Distance Charts below.

Fixed Camera 24VAC only, used with NV-216A-PV

Power Supply Voltage	24 VAC	28 VAC
Minimum Voltage at Camera	21 VAC	21 VAC
B&W Camera, 2.4 W		
2-pair 24 AWG	789ft (240m)	1,840ft (561m)
2-pair 23 AWG	994ft (303m)	2,320ft (707m)
Color Camera, 4.8 W		
2-pair 24 AWG	393ft (120m)	916ft (279m)
2-pair 23 AWG	495ft (151m)	1,155ft (352m)
Color Camera, 7.2 W		
2-pair 24 AWG	262ft (80m)	612ft (186m)
2-pair 23 AWG	331ft (101m)	771ft (235m)

Fixed Dual Voltage 24VAC/12VDC Camera with NV-216A-PV

Power Supply Voltage	24 VAC	28 VAC
Minimum Voltage at Camera	14 VAC	14 VAC
B&W Camera, 2.4 W		
2-pair 24 AWG	1,753ft (534m)	2,454ft (748m)
2-pair 23 AWG	2,210ft (674m)	3,094ft (943m)
Color Camera, 4.8 W		
2-pair 24 AWG	874ft (266m)	1,223ft (373m)
2-pair 23 AWG	1,102ft (336m)	1,542ft (470m)
Color Camera, 7.2 W		
2-pair 24 AWG	583ft (178m)	816ft (249m)
2-pair 23 AWG	735ft (224m)	1,029ft (314m)

P/T/Z 24VAC Camera used with NV-218A-PVD

Power Supply Voltage	24 VAC	28 VAC
Minimum Voltage at Camera	21 VAC	21 VAC
P/T/Z Camera, 21 W		
2-pair 24 AWG	90ft (27m)	210ft (64m)
2-pair 23 AWG	113ft (35m)	265ft (81m)

Fixed 12VDC Camera used with NV-226J-PV		
Power Supply Voltage	24 VAC	28 VAC
B&W Camera, 2.4 W		
2-pair 24 AWG	1,586ft (482m)	2,220ft (677m)
2-pair 23 AWG	1,999ft (609m)	2,799ft (853m)
Color Camera 4.8 W		
2-pair 24 AWG	795ft (242m)	1,113ft (339m)
2-pair 23 AWG	1,002ft (306m)	1,403ft (428m)

Connecting the Video Outputs from the Power Supply Passive Receiver Hub to the Control Room

Connect the equipment video outputs on the rear of the Power Supply Passive Receiver Hub to the DVR, encoder, or multiplexer.

The NV-4PS13-PVD supports four channels.
The NV-8PS13-PVD supports eight channels.
The NV-16PS13-PVD supports sixteen channels.

Data Connections

The data path for each camera arrives on the front RJ45 jack of the Power Supply Cable Integrator. Each Data jack supports the pass-through of four camera data signals. Use a 4-pair Cat5 cable to bring these data signals back to the Control Room. For small installations, these wire pairs may be connected directly to the RS-422/485 telemetry control output on your controller. In most cases a "Code Distribution Unit" (available from the camera manufacturer) is inserted between the telemetry output and the wire-pairs. This allows one telemetry output to drive many cameras without having to drive too many loads. It also prevents a fault at one camera from taking down the entire system.

NV-8PS13-PVD, NV-16PS13-PVD Rack / Table Mounting

Ambient temperature must be below 122°F (50°C). Airflow must be at least 4ft³/min of un-restricted airflow. Many DVRs produce enough heat to exceed this temperature without external airflow.

For rack mounting, (8 and 16 Channel installation described below. 4-Channel NV-4PSRMBK rack mounting brackets purchased separately). Attach supplied mounting brackets to the hub chassis using the supplied screws. Note that the brackets allow installation with the front or rear facing out.



Because the NV-16PS13-PVD weighs 25 lbs. (11,3kg), some thinner-gauge rack systems may require additional rear support. NVT provides a rear-rail mounting accessory kit (see Accessories) for this purpose.

Table Tops: (4 Channel feet attached) for 8 & 16 Channels use enclosed self adhesive rubber feet and attach to the bottom corners of the hub.

NV-8PS13-PVD, NV-16PS13-PVD Wall Mounting

Attach the optional mounting "L" brackets to two sides of the unit, using the enclosed screws. The brackets may be installed facing outward or inward. Inward facing brackets allow the unit to be mounted on 16" centers, useful in US wall stud applications. For easy connector and LED access, it is recommended that the front of the unit faces left.

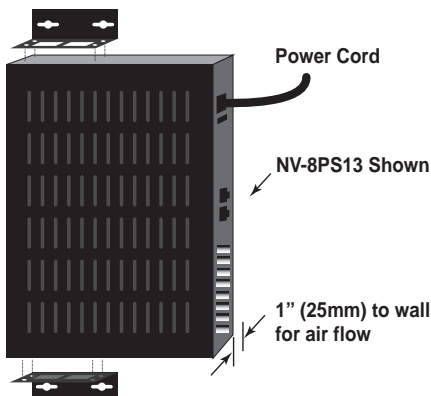

NV-4PS13-PVD Wall Mounting

For wall mounting, hang unit onto (2) Pan head screws mounted to plywood backboard. Screw heads should be secured approximately 1/2" (1,2cm) off board surface and spaced 4.5" (11,43cm) apart.

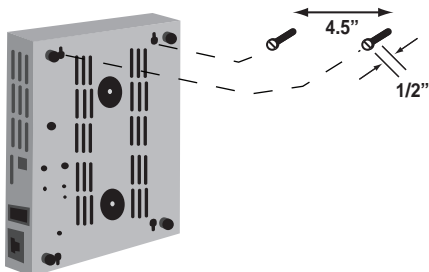

Example Data Connections and Pinouts

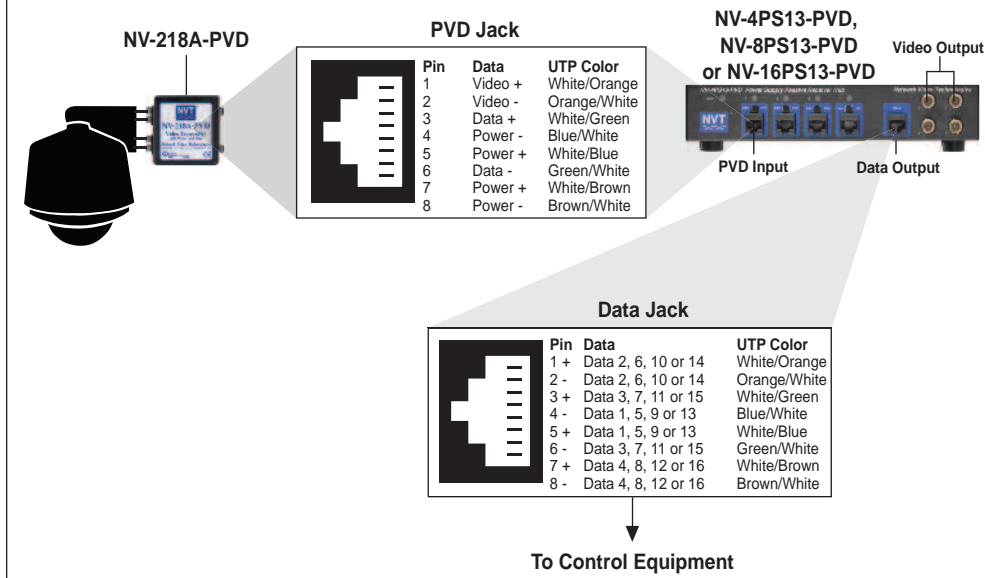

Technical Specifications

Video, Passive Receiver

Frequency	DC to 10 MHz
Attenuation	0.5 dB typ
Common Mode/Differential Mode Rejection	15 KHz to 5 MHz 60dB typ

Power Output

3 Position	24VAC, OFF or 28VAC
Voltage Switch	Per-channel switch selectable
Current	1 Amp per channel

Protection

Automatic resetting termistor

Connectors and Impedance

RJ45 UTP input	100 ± 20 ohms
BNC output	75 ohms

LEDs

Power	Blue
Channel Status	see page 1

Environmental

Temperature	32 to 122°F (0 to 50°C)
Minimum airflow	4ft ³ /min (0,1 ³ mm)
Humidity	0 to 95% non-condensing
Transient immunity	per ANSI / IEEE687 C62.41

Power Input

IEC380 Inlet

Power Cord

IEC380 AC line power receptacle for use with removable cords. Use only the power cord provided with the unit or equivalent UL approved type SJT or SVT, 18AWG, 125/250V, 5A 60 deg.C, Max. 4.5m long; One end with NEMA 5-15P. Other end with appliance coupler.

NV-4PS13-PVD

Voltage	115/230 VAC
Frequency	50/60 Hz
Wattage	125 W
Heat	50 BTU/Hr (power supply only) 420 BTU/Hr (power supply with camera)

NV-8PS13-PVD

Voltage	115/230 VAC
Frequency	50/60 Hz
Wattage	250 W
Heat	100 BTU/Hr (power supply only) 900 BTU/Hr (power supply with camera)

NV-16PS13-PVD

Voltage	115/230 VAC
Frequency	50/60 Hz
Wattage	500 W
Heat	125 BTU/Hr (power supply only) 1,200 BTU/Hr (power supply with camera)

Fuse

NV-4PS13-PVD	2.5 Amp
NV-8PS13-PVD	2.5 Amp
NV-16PS13-PVD	5.0 Amp

A spare fuse is located inside the fuse holder.

Mechanical (Excluding brackets and connectors)

Dimensions

NV-4PS13-PVD	W 9.25" (23,5cm) H 1.7" (4,4cm) D 7.3" (18,5cm)
NV-8PS13-PVD	W 17" (43,2cm) H 1.7" (4,4cm) D 8.13" (20,7cm)
NV-16PS13-PVD	W 17" (43,2cm) H 1.7" (4,4cm) D 12" (30,48cm)

Weight

NV-4PS13-PVD	Product Weight 7.0lb (3,14kg) Packaged Weight 8.42lb (3,81kg)
NV-8PS13-PVD	Product Weight 14lb (6,35kg) Packaged Weight 16.8lb (7,6kg)
NV-16PS13-PVD	Product Weight 25lb (11,3kg) Packaged Weight 30.4lb (13,78kg)

Accessories

NV-4PS13-PVD

- Rubber feet for desk applications (attached)
- Hole cutouts in bottom for wall mount
- Power cable IEC power cord 7ft (21,5cm)
- BNC patch cables: 2ft long purchased separately
- NV-4PSRMBK (rack mount kit) purchased separately

NV-8PS13-PVD and NV-16PS13-PVD

- Mounting: Rackmount "L" brackets for front or rear installations; rubber feet for desk applications
- Rack screws: 4 12-24 x 3/4" Phillips Pan Head
- BNC patch cables: 2ft long 1 per channel
- Power cable IEC power cord 7ft (21,5cm)
- Optional Mounting Support Bracket Kits
- Model NV-RMBK (rear mount kit) purchased separately
- Model NV-WMBK (wallmount kit) purchased separately

Agency

These NVT products are listed and/or conform to the following certifications and directives:



UL Listed to UL2044 or UL/IEC 60065.

cUL Listed to CAN/CSA22.2 No. 1 for Canada.

CE Mark under EMC and low voltage Directives for the European Union.

Complies with FCC part 15B limits

Troubleshooting

If you are experiencing problems, attempt to simplify your setup. Test each cable segment separately. For example, test the camera and monitor together without the other equipment. Then add in the NVT transceivers, back-to-back. Test each segment of a long cable-run independently. Attempt to isolate the problem.

Customer Support

NVT customer support is available for consultation from 8:00 AM to 5:30 PM PST Monday through Friday. In addition, emergency after-hours callback support is available.

US Office:	(+1) (650) 462-8100
US Fax:	(+1) (650) 326-1940
UK Office:	(+44) (0)20 8977 6614
UK Fax:	(+44) (0)20 8973 1855
Email USA:	www.nvt.com/email
Email UK:	www.nvt.com/email
Web home page:	www.nvt.com

Returns

Please call before returning units to NVT. Returned materials must have a "Returned Materials Authorization" (RMA) number from NVT marked on the outside of the shipping carton.

Limited Lifetime Warranty

NVT warrants that the product conforms to NVT's applicable published specifications and is free of defects for the life of the product. There shall be no other warranties, express, statutory, or otherwise, including any implied warranty of merchantability, of fitness, or any other obligation on the part of NVT with respect to any of the products.

In the event that any of the products is damaged, altered, or modified without the express written consent of NVT, any warranty for those products will cease and NVT will have no further liability as it pertains to those products.

NVT assumes no responsibility for damages or penalties incurred resulting from the use of this product in a manner or location other than for which it is intended.

NVT's liability under any warranties shall be discharged by replacing or repairing any part or parts which do not conform to the applicable warranty under normal and proper use. NVT's liability with respect to any product shall not exceed a refund of the price received by NVT for that product, and in no event shall NVT have any liability for any incidental, consequential, special, or indirect damages.

Some states do not allow the exclusion or limitation of special, incidental, or consequential damages, so the above limitations or exclusions may not apply to you. This warranty gives you specific legal rights, and you may also have other rights which vary from state to state.

Specifications subject to change without notice